

Fast Display AE 903.2x

Original of
Manual

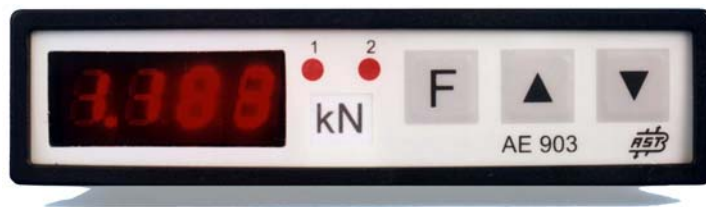

A.S.T. - Angewandte System Technik GmbH, Mess- und Regeltechnik

Marschnerstraße 26 01307Dresden

Telefon (03 51) 44 55 30 Telefax (03 51) 44 55 555

www.ast.de vertieb.dd@ast.

Index of contents

1. Field of Application	1
2. List of Items Supplied	2
3. Technical Specification	3
3.1.1. Display unit type	3
4. Description of the Display Unit	4
5. Operating instructions	5
5.1. Description of Key Functions and Trigger Input.....	5
5.2. Description of display	6
5.3. Commissioning and measurement.....	7
5.3.2. Installation	7
5.3.3. Pin Configuration and Wiring.....	7
5.3.4. Switching On and Off.....	10
5.3.5. Measurement.....	10
5.3.6. Entry of Limits	11
6. Serial Interface	12
6.1. Type of Interface.....	12
6.2. Transfer of Measured Data	12
6.3. Commands:	13
7. Programming (SETUP) and Calibration	16
7.1. Function of Keys in Mode SETUP	16
7.2. Numerical input.....	16
7.3. Main menu	17
7.4. Sub Menus	18
7.4.1. Calibration	18
7.4.2. Selection of Filter Averaging Time	21
7.4.3. Serial Interface	21
7.4.4. Parameters of the Limits (Set Points).....	22
7.4.5. Scaling of Analog Output.....	24
7.4.6. Overload and Underload Limits.....	25
7.4.7. Power-On Zero Range	25
7.4.8. To Select the Function of the Trigger Input.....	26
8. PC Programm	26
9. EC Declaration of conformity	27

1. Field of Application

AE 903.2x is a programmable high-speed indicating unit dedicated to the connection of transducers which are based on four-arm strain-gauge bridges, preferably force transducers. It can be used as a force measuring device for the measurement of quasi-stationary and dynamic events. Measured results can be transferred through its serial interface to a processing device, e.g. a PC, at a transfer rate of 320 per second.

There are two limit switches which can be used for signalling whether the measured value exceeds or falls below one or both of two adjustable limits.

The device is equipped with a maximum memory.

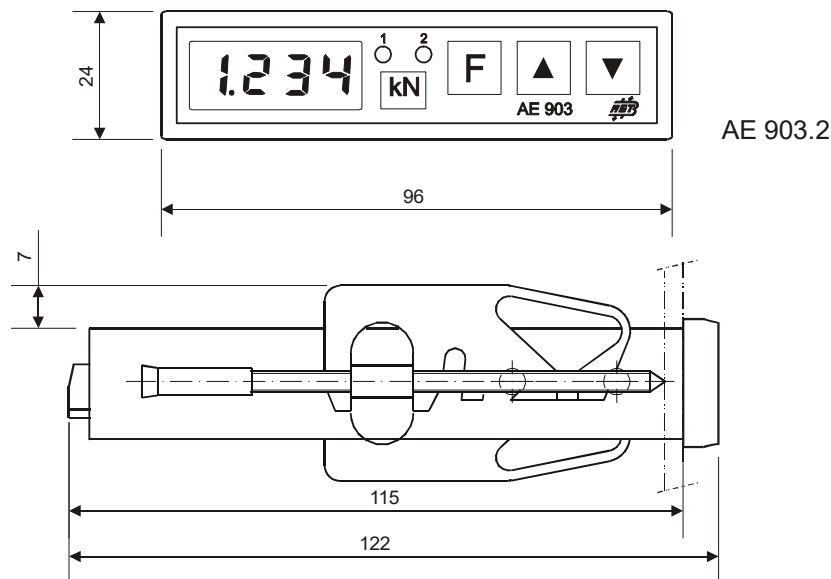

Attention!

Do not employ the Fast Indicating Unit as the only means to prevent dangerous conditions of your machinery and systems. Make sure that your machinery and systems are so designed that any erroneous condition will in no case result in a dangerous situation. Take all necessary steps to ensure that no operating error can lead to material damage or danger to the life and limb of the operating staff or third parties.

2. List of Items Supplied

Type code/ versions

AE 903.21	Indicating unit with 4-digit LED display and keyboard RS 232 not insulated, UB (18...30V DC) not insulated
AE 903.22 (on request)	Indicating unit with 4-digit LED display and keyboard RS 232 insulated, UB (18...30V DC) not insulated
AE 903.23	Indicating unit with 4-digit LED display and keyboard RS 485 not insulated, UB (18...30V DC) not insulated
AE 903.24 (on request)	Indicating unit with 4-digit LED display and keyboard RS 485 insulated, UB (18...30V DC) not insulated
AE 903.25	Indicating unit with 4-digit LED display and keyboard RS 232 not insulated, UB (18...30V DC) insulated
AE 903.26 (on request)	Indicating unit with 4-digit LED display and keyboard RS 232 insulated, UB (18...30V DC) insulated
AE 903.27	Indicating unit with 4-digit LED display and keyboard RS 485 not insulated, UB (18...30V DC) insulated
AE 903.28 (on request)	Indicating unit with 4-digit LED display and keyboard RS 485 insulated, UB (18...30V DC) insulated

Optional extras

XKS 030	PC program for Indicating Unit AE 903
XKC 259	RS232 interface adapter for AE 903
XKC 260 (on request)	External keyboard for AE 903

3. Technical Specification

Display unit type		AE 903.1x 3-digit red LED with bar-graph range -99 ... 999	AE 903.2x 4-digit LED range -999 ... 9999
Input			
Sensitivity S *)	mV/V	0,5 / 1,0 / 2,0 / 4,0	
Transducer excitation	VDC	approx. 10	
Supported transducers		max. 2 parallel connected full bridges (350 Ω)	
Display			
Display height	mm	7,62	
Count by step		1 / 2 / 5	
Display resolution at full scale	div.	approx.. 2000	
Display modes		Instantaneous value (= average over 50ms to 800ms) maximum value, overload, underload Indication of condition of limit switch by means of two LED **)	
Tare		whole display range	
Display rate	1/s	20	
Internal measuring rate	1/s	320	
Internal Resolution at Sensitivity S=2mV/V	div.	> 2000	
Noise at S=2mV/V		approx. 1 (when averaging 50 ms)	
Output			
Analogue output		0...4V – display range freely selectable	
Set points		2 isolated relay outputs 42V/0,1A, 2 LED	
Serial interface		RS 232 or RS 485	
	1/s	1 start bit, 8 bit data length, 1 stop bit, 9600 or 19200 baud 320 measured values per second	
Power supply			
Supply voltage / Current consumption	VDC / mA	18/max.160...30/max.100	
Switch on current at 24V	A	approx. 1 (20ms)	
Environmental conditions			
Operating temperature range	°C	0...+50	
Storage temperature range	°C	-20...+70	
Errors for S=2mV/V			
Display error	%S	±0,2 ... ±0,5	
Data through serial interface	%S	±0,5	
Temperature effect on output / 10K	%S	type ±0,05 , max ±0,1	
Temperature effect on zero / 10K	%S	±0,1	
Construction			
Dimensions (W x H x D)	mm	96x24x122	
Panel cut out	mm	92 ^{±0,2} x22 ^{±0,2}	
Weight	g	approx. 150	
Environmental protection (EN 60529)		IP40	
Connectors: transducer, analogue output, supply voltage, relay output, Trigger signal input		8 pin screw terminal strip, (0,14...1)mm ²	
Serial Interface, keyboard		2*5 pin connector, 2,54mm	

4. Description of the Display Unit

The instrument is equipped with a microprocessor which takes full command of measurement processing. The applied measuring signal is fed to an analog-to-digital converter which performs 1280 conversions per second. Since each time four values are averaged, the measuring rate is 320/s. The display is updated every 50ms after groups of 16 values have been averaged successively. Heavily fluctuating indications can be smoothed by feeding the 50-ms values to a moving average filter the averaging time of which can be adjusted. The display will indicate the output values of this filter.

The indicating range covers numbers between -999 and 9999.

The input voltage range (which is equivalent to the transducer sensitivity rating) for full-scale indication is set by the manufacturer according to the customer's demand. It can be changed by re-positioning jumpers after the device has been opened.

The display unit is equipped with a maximum memory. There is also a zero setting (taring) facility which allows any zero voltage of the transducer or initial load to be compensated for within the full display range.

The measuring value can be read out through the serial interface and as an analog voltage (0 to 4.000V).

There are two floating limit outputs which allow the device to be used as a threshold switch.

The keyboard is for running, scaling and calibrating the AE903.2x. The trigger signal can be used for taring, for resetting the stored maximum or for inserting a tag in the serial output signal.

The Display Unit is powered from 24VDC. The device is housed in an enclosure for switchboard mount 24mm x 96mm.





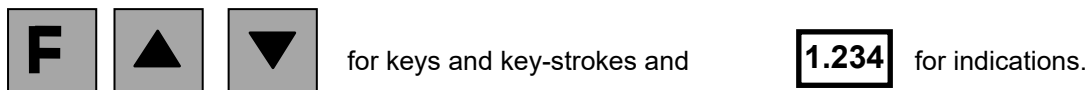

5. Operating instructions

5.1. Description of Key Functions and Trigger Input

The key functions are tripped by pressing a key briefly or for a longer time, respectively. A brief key stroke means pressing the key for at least 0.2 seconds, a long key stroke requires the key to be pressed for at least 3 seconds. Each time a key is pressed for a longer time, first the function allocated to the brief key stroke will be executed.

The following symbols will be used:



Key	Function	
	Brief key-stroke	Long key-stroke
	Maximum indication flashing dot on the right-hand side	
	Indication of instantaneous value and brief indication of its mode: 'net' -> '1.234' indication of net 'gros' -> '1.234' indication of gross	Delete the tare memory -> indication of gross In effect only with indication of instantaneous value.
  simultaneously	Reset to zero (taring) of the instantaneous value Change-over to indication of net *)	
  simultaneously	Reset of maximum indication to the current instantaneous value In effect only with indication of maximum value.	
		Change-over to limit input See clause 5.3.5

*) After taring, gross can be indicated only after deleting the tare memory.

The key functions for limit input (clause 5.3.5) and for SETUP / Calibration (clause 7) will be dealt with in the clauses mentioned.

Function of Trigger Input

A tag indicating the state of the trigger signal is always included in the output telegram of the fast force measuring value transmitted through the serial interface.

At the stage of SETUP (clause 7.4.8), the trigger input can be allocated one of the following functions:

Setting of SETUP	Function
OFF	none
t	to reset the instantaneous value to zero (taring) -> indication of net
CP	to delete the maximum value and reset it to the instantaneous value
t CP	to reset the measured value to zero (taring) -> indication of net and to delete the maximum value and reset it to the instantaneous value

The function is released by a positive trigger pulse (12V ... 30V).

The pulse must have a duration of at least 150ms but must not exceed 10s.

The trigger signal function will be executed irrespective of the currently selected mode of display (average or maximum).

5.2. Description of display

display	meaning
X.XXX	Indication of instantaneous value. Leading noughts will not be indicated.
X.XXX. flashing decimalpoint to the right	Maximum indication
N E t	indication of net value.
G r o S	indication of gross value.
▯▯▯▯	Overload indication
▯▯▯▯	Under load indication
- - - ▯	Overload of ADC input
- - - ▯	Under load of ADC input
S P 1	Input limit 1
S P 2	Input limit 2

LED 1 is on if limit 1 is exceeded.

LED 2 is on if limit 2 is exceeded.

5.3. Commissioning and measurement

5.3.2. Installation

Insert the Display Unit in a switchboard cut-out with dimensions 92mm x 22mm and attach it by means of the supplied fixing braces.

For how to wire the AE903, please refer to the following clause.

5.3.3. Pin Configuration and Wiring

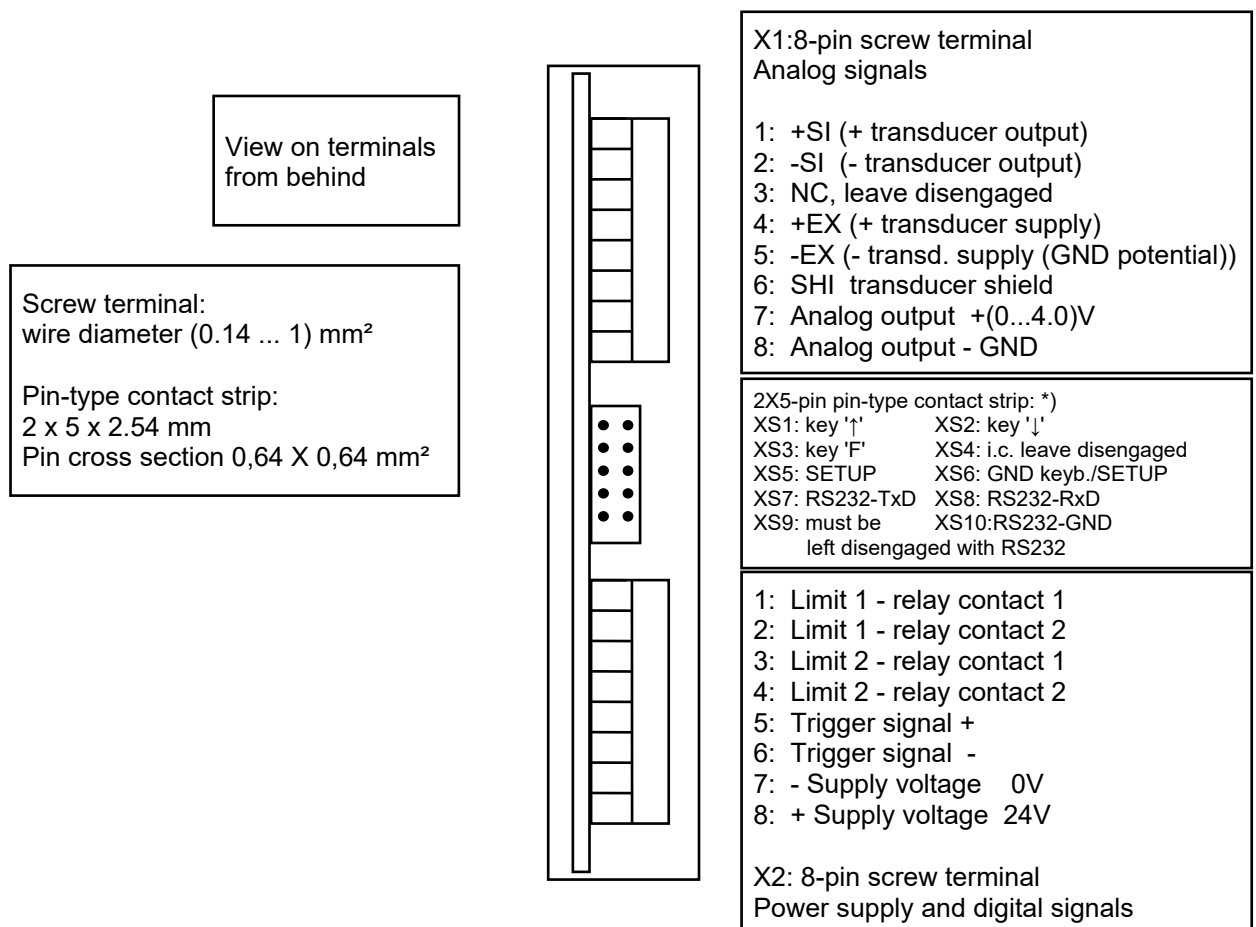

*) With RS485 interface, the following pins are optionally engaged:

XS7: RS485-A XS8: RS485-B XS10: RS485-GND

XS9: terminating resistor RS485 (120Ω), effective if XS7 is connected to XS9

Description of Terminals

Screw terminals for Analog signals

Transducer connection:

The Display Unit accepts transducers based on strain-gauge bridges in four-lead configuration down to a minimum input resistance of 150Ω . The supply voltage of the bridge may be between 4V and 7V.

Maximum transducer cable length: 20m, wire cross section: at least 0.25 mm^2 .

With this cable length and connection of a 350Ω -transducer, the sensitivity of the transducer is approximately 1 % reduced. This error can be compensated for by calibrating the AE903. What remains is the temperature coefficient of the copper cable which causes an error of approx. $0.03\% / 10\text{K}$.

Analog output:

At the stage of SETUP, the output voltage range of 0V to 4V can be allocated to a selectable indicating range. The internal resistance of the output is approx. $2.5\text{ k}\Omega$. The output is short-circuit proof.

Further it can be selected whether the output voltage is derived from the normal measured value or from the maximum value.

Screw terminals Power supply and Digital signals

Supply voltage

The device is on as soon as supply voltage is applied. The supply voltage shall be in the range between 18V and 30V. While the device switches itself on, short-term (20 msec) current peaks of up to 1 A may occur.

The device is protected against wrong polarity.

Protect the AE903 by means of an external fuse 0.5 A, slow-acting.

Relay outputs

The relay outputs are floating reed relay contacts, they are able to switch voltage up to 42 V and current up to 0.1 A. The mode of switching (making contact or breaking contact in case a limit is exceeded) can be selected at the stage of SETUP. **Both relay contacts are open when the device is off.**

The contacts are not protected against overvoltage and overcurrent.

When inductive loads are connected, the contacts must be protected by external arc-extinguishing circuitry (varistors, free-wheeling diodes).

Trigger input

The trigger input signal can be used for tagging an event when transferring data through the serial interface. This is accomplished by including the logical state of this input in the measured data by way of a status bit. Furthermore an operating function can be allocated to the trigger input as described in 5.1.

The input is floating due to the use of an opto-coupler.

The input is LOW if not wired up.

2 x 5-pin pin-type contact strip

External keys

The inputs are for connecting an external keyboard.

The key inputs are arranged in parallel to the keys on the front panel of the device. They are enabled by connection to GND. The inputs are HIGH if not wired up.

Input i.c. is without function, it must not be wired up.

SETUP

This input calls the SETUP and calibration programs when connected to GND. This may be accomplished, for instance, by connecting the two central pins by means of a 2.54mm jumper.

Neither SETUP nor calibration can be performed if the inputs are not wired up (works as a programming lock)

The key inputs and the SETUP input are not protected against overvoltage.

Serial interface

RS232 Signals are used for making connection to the serial COM port of a PC. Commands can be transmitted through the interface to the AE903 or measured data can be transferred from the AE903 to the PC at high speed.

Maximum cable length of the RS232 interface: 15 m

If you want to adapt the pin-type contact strip to a 9-pin PC interface cable, you may use the interface adapter XKC259 which is available as an optional extra. When plugging the adapter in, the red wire shall be to the left (viewing from behind at the connectors).

Optionally the interface connectors may carry the **RS485 Signals** A, B and GND.

You will need to insert an appropriate interface converter (e.g. type GR1BN by NEWPORT) if you want to connect a device with RS485 interface to the COM port of a PC.

When running the device in an environment with strong electromagnetic fields, you will be able to reduce any possible interference by threading the transducer cable and the power cable (plus and minus wires jointly) each through a hinged core. Attach the hinged cores in the vicinity of the contact strip.

Hinged core: e.g. type 74271131 by Wuerth Elektronik, supplier: RS Components GmbH and others

Change of Sensitivity S for Full Scale

Sensitivity S is set by the manufacturer in line with your order. Make any changes only in exceptional circumstances since you will need to carry out mounting operations.

How to dismantle the AE903:

- Remove both stoppers in the rear of the device by pressing them out of the pc board (from below).
- Pull off front panel frame.
- Cautiously shift the pc board to the front until the front panel can be taken out.
- Remove the three push-button heads.
- Cautiously push the pc board out of the enclosure.

Set or remove jumpers 1, 2 and 3 according to table. Jumpers 1 and 2 are for adjusting the gain of the device. These jumpers will be accessible after bending the shielding foil upwards.

Jumper 3 is for selecting unipolar or bipolar mode of operation.

How to re-assemble the device: as above, but in reverse order

Attention! Make sure that both stoppers are re-inserted!

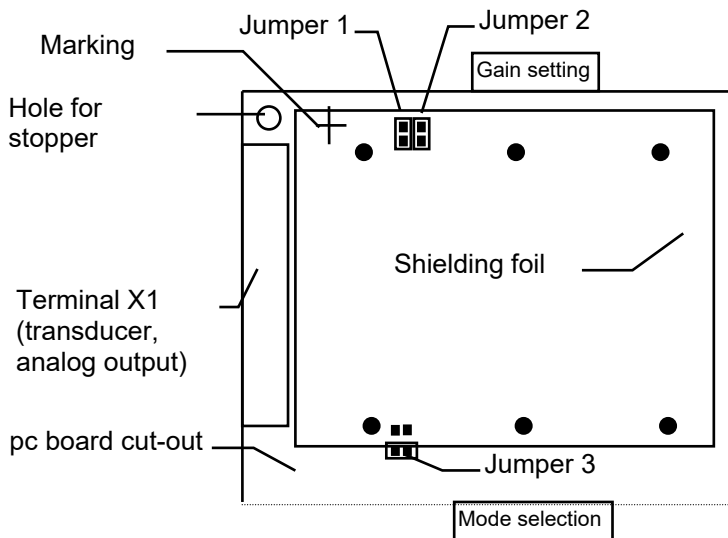

Table Gain setting

Sensitivity S, mV/V, ca.	Jumpers 1 and 2
0.5	
1	
2	
4	

Table Mode selection

Mode	Jumper 3
unipolar	
bipolar	

5.3.4. Switching On and Off

By applying or disconnecting the 24 V supply voltage, respectively. Upon switching on, the instantaneous value can be set to zero. The zero setting range is specified at the stage of SETUP.

5.3.5. Measurement

Having been switched on, the AE903 will indicate the instantaneous value.

Serial interface

For the functions that can be released by commands through the serial interface, please refer to clause 6. After command 'Continuous transfer of measured data' has been given, the device will transmit 160 or 320 independent measuring values per second, depending on the selected Baud rate, to the connected evaluation device (e.g. PC).

Limits

Limit LEDs '1' and '2' are on if the pre-selected limits have been exceeded.

Simultaneously the limit relays are switched.

The way of returning to the under-limit state is dependent on which type of measuring value has been selected for limit comparison at the stage of SETUP.

Mode instantaneous value:

After the limit switch has responded, it will immediately return to the under-limit state once the measured value has fallen below the limit by the hysteresis margin.

Mode maximum value:

Limit switch and indication will return to the under-limit state only after the stored maximum value has been deleted and the measured value has fallen below the limit by the hysteresis margin.

You may change either limit by keyboard entry (clause 5.3.5)

Analog output

The analog output will carry a voltage of between 0 V and 4 V according to the SETUP setting. The output voltage is updated 320 times per second.

In the Setup it can be selected whether the analogue output is headed for by the normal measured value or the maximum value. In the latter case we a "function of pointer of dragging" reaches. By keyboard entry, trigger signal or command "deletion" and/or. "resetting maximum value" can be reset the expenditure for maximum value to the current normal value.

Limit switches and analog output are controlled by the gross value for the un-tared system or by the net value for the tared system

Error messages

Overload indication	is triggered if the gross value exceed the overload limit as set at the stage of SETUP or if the measured value exceeds the positive indicator range.
Underload indication	is triggered if the gross value falls below the underload limit as set at the stage of SETUP or if the measured value falls below the negative indicator range.
Overload	is read out if the internal ADC value exceeds the admissible maximum value.
Underload	is read out if the internal ADC value is equal to or falls below the admissible minimum value.

5.3.6. Entry of Limits

For calling the Entry of limits mode, press key **F** for a longer time. The indicator will show the limit value which has been in effect so far. After a limit has been changed, its value is stored in non-volatile manner in the EEPROM of the device. The value of hysteresis and the switching mode of the limit relays will not be affected.

For calling the Entry of limits mode, please refer to the following scheme:

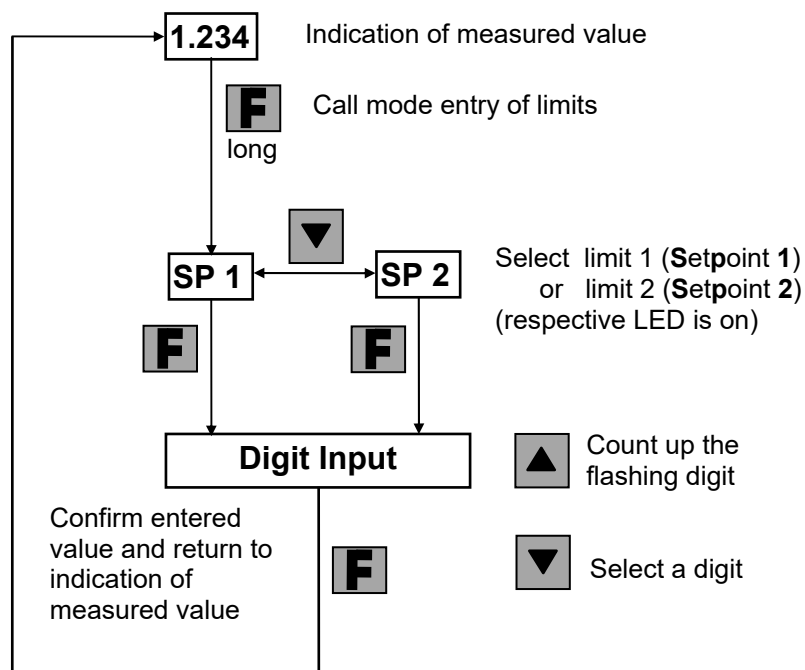

The limit entry facility can be disabled for both limits or only one of them. You may do so at the stage of SETUP

If entry of both limits is disabled, pressing **F** for a longer time will have no effect.

If entry is disabled for only one of either limits, any attempt to enter the disabled limit will result in a brief indication of 'dis' (Input disable) and the device will return to entry of the limit that is not disabled.

6. Serial Interface

The serial interface is for transmitting the measured data to a connected evaluation device, e.g. a PC, and for transmitting commands to the AE903.

6.1. Type of Interface

The default configuration of the serial interface is as an RS232 interface. The device may be also be supplied with an RS485 interface on demand. In this event the maximum cable length is 1200 m (15 m for RS232 interface).

If the RS485 interface is used, up to 32 devices can be connected to the RS485 bus. Connection to the COM interface of a PC then requires an RS232-RS485 converter (e.g.: type GR1BN by NEWPORT).

6.2. Transfer of Measured Data

The measured data are transferred using a dedicated 3-byte data format.

The transfer is controlled by serial commands. The measured data can be read out in the form of individual values, blocks of between 2 and 65534 successive values or a continuous stream of measured values.

The data transfer rate is dependent on the Baud rate selected at the stage of SETUP:

Baud rate	Data transfer rate
9600	160/s
19200	320/s

Data format of a measured value

Every measured value is transferred as a group of three bytes.

Each byte is made up of a 2-bit header (bits 7 and 6) and 6 bits of data. Header 11xxxxxx of the 1st. byte labels this byte as being the start byte. The following two bytes each have a header of type 10xxxxxx.

The bytes are encoded as follows:

Byte 1 - Bit								Byte 2 - Bit								Byte 3 - Bit							
7	6	5	4	3	2	1	0	7	6	5	4	3	2	1	0	7	6	5	4	3	2	1	0
Header		Status bits				Meas.value		Header		Measuring value						Header		Measuring value					
1	1	S3	S2	S1	S0	M13	M12	1	0	M11	M10	M9	M8	M7	M6	1	0	M5	M4	M3	M2	M1	M0

M0 to M13 make up the measuring value. This value includes an offset of 1000 and is derived from the internal measuring value supplied at a rate of 320 Hz:

Transferred value = internal measuring value + 1000.

The internal value is different from the indicated value only by the fact that the indicated value is filtered more strongly (averaging filter 50ms (16 internal measuring values) to 800ms (256 internal measuring values)).

Since the indicating range extends from -999 to +9999, adding the offset has the result that only positive values are transferred.

The measuring value already includes the incremental width 1, 2 or 5.

It does not include any information about the decimal point. You will need to call this information by entering command 'D' before starting the transfer.

Status Bits

S0: Trigger bit 0: Trigger input Low
1: Trigger input High

S0 is included in every measuring value.

Encoding of S1 to S3 and meaning of S1 and S2

S3 may change with each transfer of measured data. This bit identifies the meaning of bits S1 and S2 according to the following table:

S3	Function
0	S1: limit 1, bit will be set if limit is exceeded
0	S2: limit 2, bit will be set if limit is exceeded
1	S1: 0: only calibrated zero is enabled (gross) 1: measured value set at zero (net)
1	S2: 0: no underload or overload 1: underload or overload This bit will be set according to the conditions specified in clause 5.3.4 'Measurement'.

To obtain full information about the measured data, at least two successive measuring values must be transferred.

6.3. Commands:

Structure of the command string:

[‘C’]<ADRH ><ADRL><Command>[CR]

Every command is made up of

Command Header

‘C’ - for labelling as a command

ADRH, ADRL two ASCII digits as device address ‘00’ to ‘99’,

With RS232: Always use ‘00’ !

Command Core

<Command> The command proper, length variable

and Command End

[CR] ODH - (carriage return)

Attention : The length of each command must not exceed 32 Bytes!

List of Commands

<SPACE> - space character

Content of command core <Command>:

['C'] Continuous transfer of measured data is enabled - (not applicable to RS485)

['D'] Read decimal point Response: 'Dn<CR>' n: 1,2 or 3 – number of digits behind point ...

['K'][n] Simulation of key stroke
n: ASCII NUMBER '1' ... '8'

n	Simulated key stroke	Function
'1'	'F'	none
'2'	'↑'	Switch over to indication of maximum
'3'	'↓'	Switch over to indication of average
'4'	'F' and '↑' simultaneously	Delete maximum
'5'	'F' and '↓' simultaneously	Set to zero (taring)
'6'	'F' long	Call Entry of limit value by keyboard
'7'	'↑' long	none
'8'	'↓' long	Reset to indication of gross

['L1?'] Inquiry limit 1 Response: ['L1']<SPACE>[||||][CR]

['L2?'] Inquiry limit 2 Response: ['L2']<SPACE>[||||][CR]
[||||] - 4 ASCII digits limit, decimal point is omitted
for negative values the first | is a minus sign '-'

['L1'][VZ][||||] Set limit 1 [VZ] Sign '+' or '-'

['L2'][VZ][||||] Set limit 2 [||||] Limit, decimal point is omitted

['M']<SPACE>['nnnnn'] (7 characters)
Request for transfer of nnnnn measuring values
nnnnn 5 ASCII digits ->number of measuring values to be transferred
nnnnn = 00000 stop the transfer of measuring values
nnnnn = 65535 continuous transfer of measuring values (not applicable to RS485)

['R'] Reset maximum value

['S'] Stop transfer of measuring values (not applicable to RS485)

['T'] Set to zero (Taring)

['W'] Read Width of indicating increment Response: 'Wn<CR>' n: 1,2 or 5

['X'] Transmit indicated value (average weighted according to selected filter) as ASCII string,

Response:

[‘B’|‘N’][‘O’|<SPACE>|‘U’][VZ][aaa.a]R’[r1r2][CR]

[‘B’ ‘N’]	Gross or net
[‘O’ <SPACE> ‘U’]	‘O’ - overload SPACE – normal range ‘U’ - underload
[VZ]	Sign of indicated value, Space for positive value
[aaa.a]	4-digit indicating value including decimal point If no decimal point has been set, the last character is Space
R’[r1r2]	State of limit relay, order: limit 1, limit 2 r1:- ‘0’ - relay released, ‘1’ - relay pulled up r2:- ‘0’ - relay released, ‘1’ - relay pulled up

Example:

It is assumed that the RS232 interface is used in all cases, i.e. address = ‘00’

1 Inquiry of measuring value:

Command:

‘C00X’[CR] 5 characters

Response:

‘B’<SPACE>‘-00.15R10’[CR] 12 characters

Gross value in normal range, measuring value -00.15

Limit relay 1 pulled up

Limit relay 2 released

2.. Read maximum value and return to indication of average:

(Assumed setting of decimal point: **123.5**)

Command sequence:

‘C00K2’[CR] Switch over to indication of maximum

‘C00X’[CR] Read the measuring value

Assumed response: ‘B’<SPACE><SPACE>‘100.5R00’[CR]

i.e. maximum gross was 100.5, both limit relays released

‘C00K3’[CR] Switch over again to indication of average

3. Set limit 1 to 120.0

Kommando:

‘C00L1+1200’[CR]

4. Transfer 100 measuring values

Command

[‘C00M’]<SPACE>[‘00100’][CR] - Total length: 11 characters



The measuring value will be transmitted using the dedicated 3-Byte format.

With RS485, continuous transfer cannot be implemented, since otherwise the RS485 bus would be permanently seized by the AE903 transmitting measuring values

7. Programming (SETUP) and Calibration

The Indicating Unit can be programmed and calibrated only if the programming lock has been disabled. You can do so by shorting (e.g. using the 2.54 mm jumper) the SETUP input (two central pins on the 10-pin contact strip in the rear of the device).

7.1. Function of Keys in Mode SETUP

Key	Function
	<p>On main menu: To change over to the selected calibration or setup menu</p> <p>On selected menu: To confirm the menu item, to store a setting or a setup parameter and to change over to the next menu item</p> <p>At the last item of the selected menu: To store the setting or a setup parameter and return to the main menu</p>
	<p>Only for numerical entry: To count up the selected digit</p>
	<p>Within a menu item: To select a setting or a setup parameter</p> <p>For numerical input: To select the digit to be set</p>

7.2. Numerical input

Having called mode numerical input, the value which has been in effect so far will be indicated. The left digit is flashing. The flashing digit can be set.

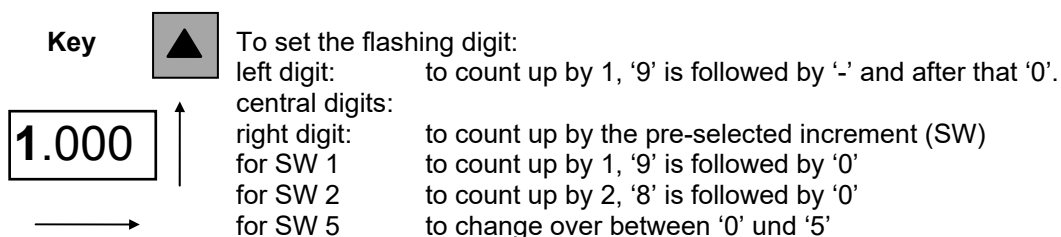

Key  To select the flashing digit which can be set. To return to the left digit after the right one has been done

Key  To store the numerical value and change over to the next menu item

7.3. Main menu

The SETUP menu appears after the two central pins of the 10-pin contact strip have been connected with one another (disabling the programming lock). It starts with Calibration menu 'CAL'. The CAL menu includes settings which have relevance to other menus, too (decimal point, indicating increment). For this reason you must always start with the CAL menu.

to select the sub menus, 'P on' is again followed by 'triG'

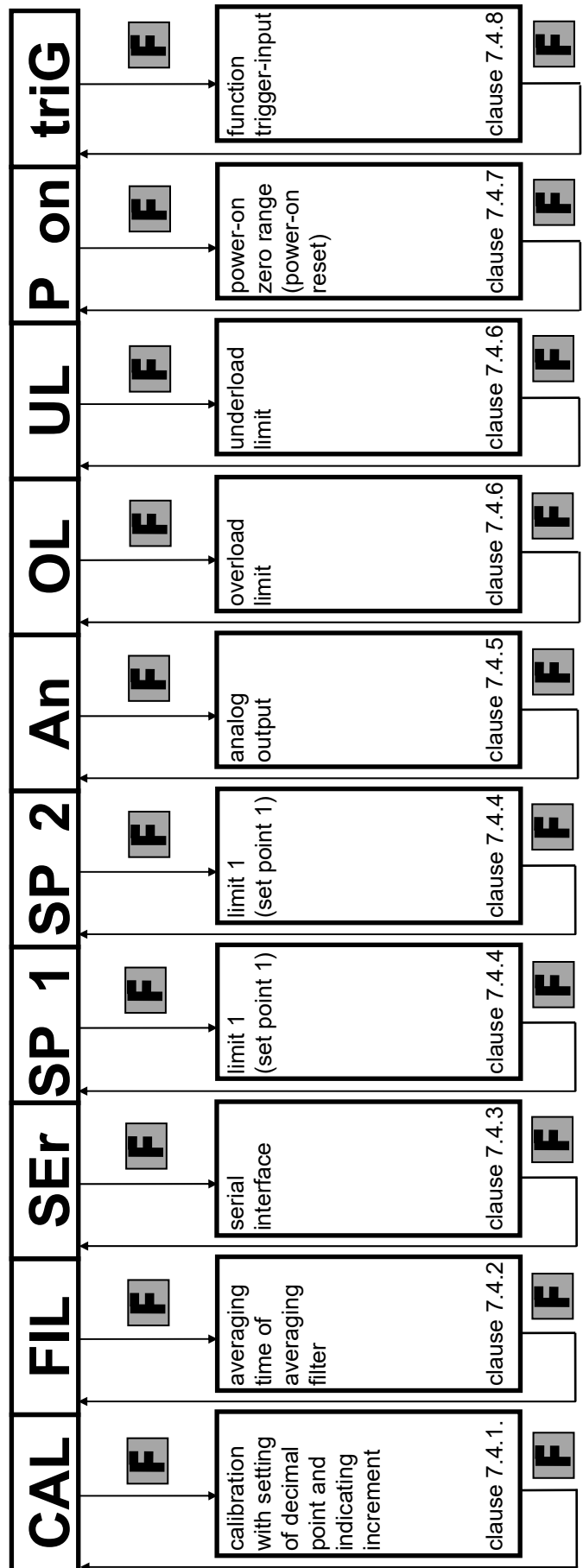

7.4. Sub Menus

7.4.1. Calibration

By calibrating, the indicating value is assigned to the output voltage of the connected transducer for all possible loads. You can linearize the transducer characteristic by specifying up to five calibration points.

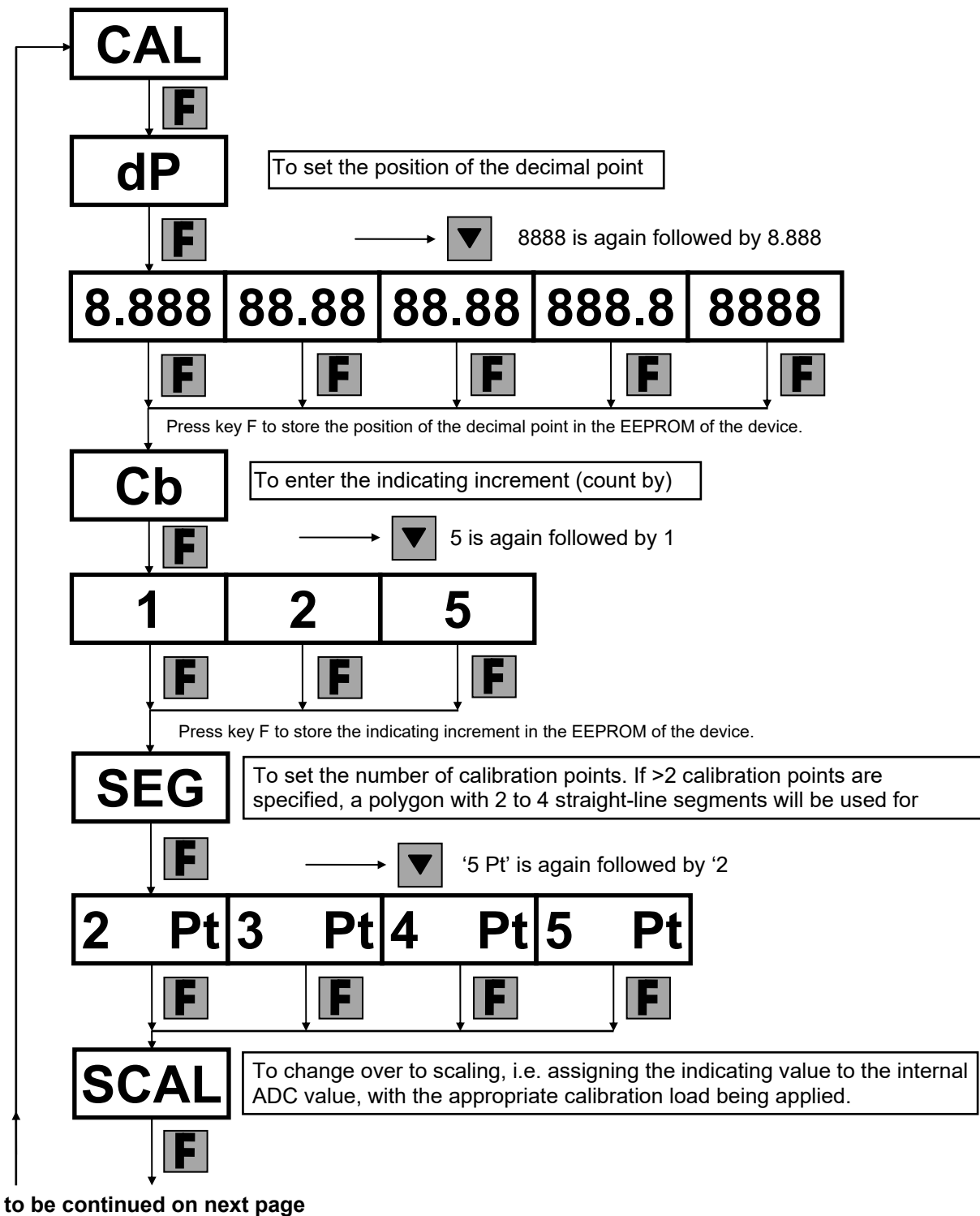

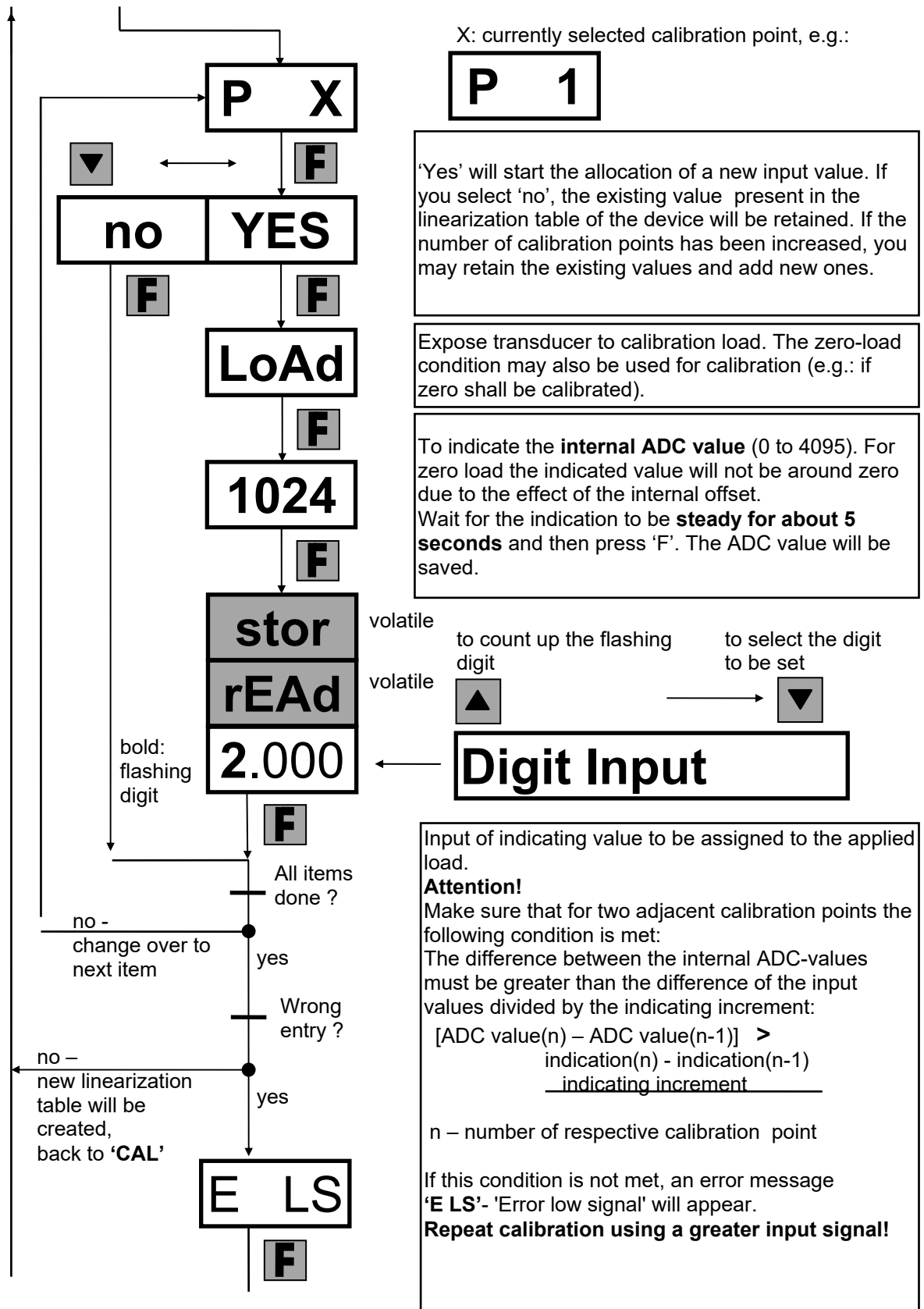

←
back to 'CAL',
existing linearization
table will not be
changed

7.4.2. Selection of Filter Averaging Time

This sub-menu is for setting the averaging time of the moving averaging filter. The filter has an effect only on the indication of the device. The transfer of measured data through the serial interface and the analog output will not be affected.

The input and output rates of the filter are 20/s. Averaging time can be set at between 50ms (no additional filtering) and 800ms. Please note that, depending on the selected averaging time, the output value of the filter is formed by taking between 2 (at 100 ms) and 16 (at 800 ms) incoming input values into consideration.

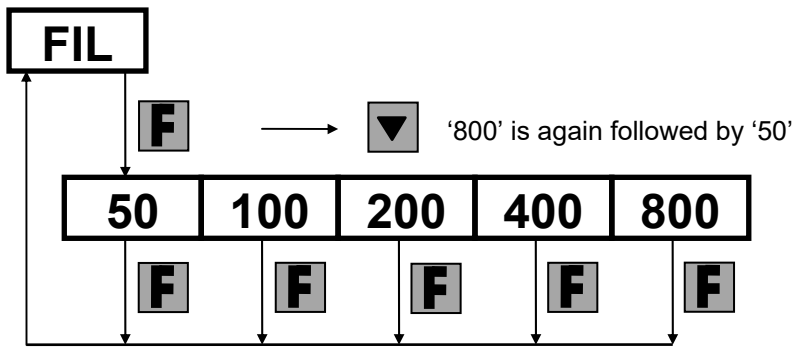

7.4.3. Serial Interface

The type of interface RS232 or RS485 is set by the manufacturer according to the customer's order. It cannot be changed. The RS485 interface allows several devices to be operated on a BUS. A device address is needed for addressing a device. The RS232 interface does not need any device address as it always works using the 'broadcast' address '00'. For this reason item 'Input of address' is skipped in devices with RS232 interface.

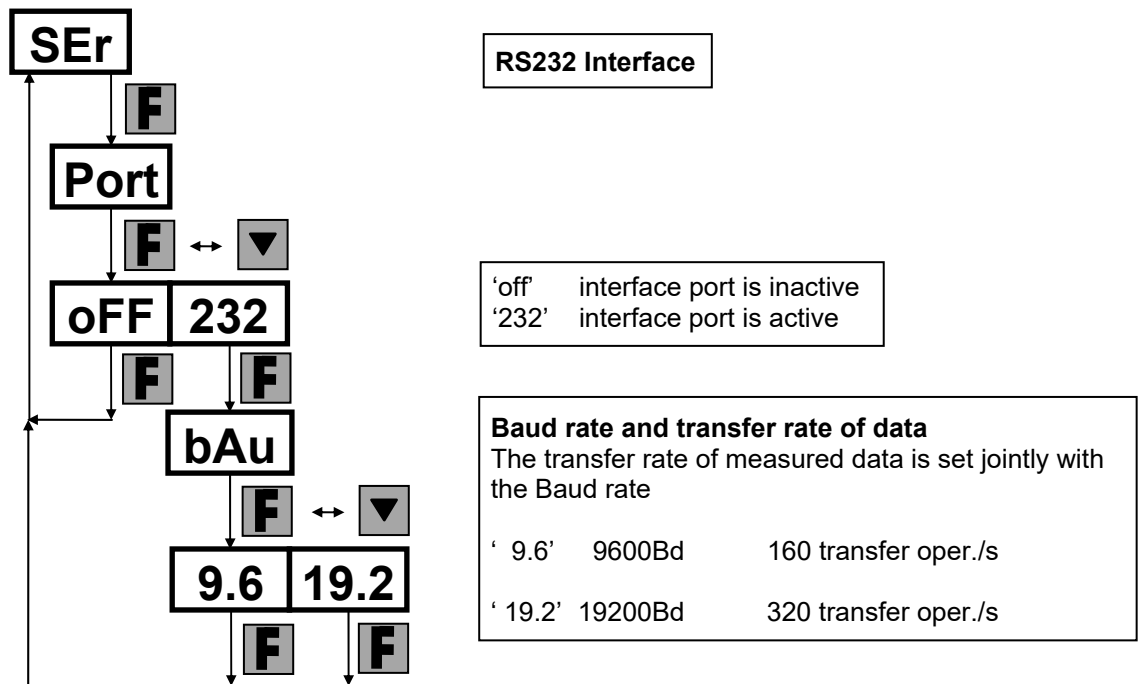

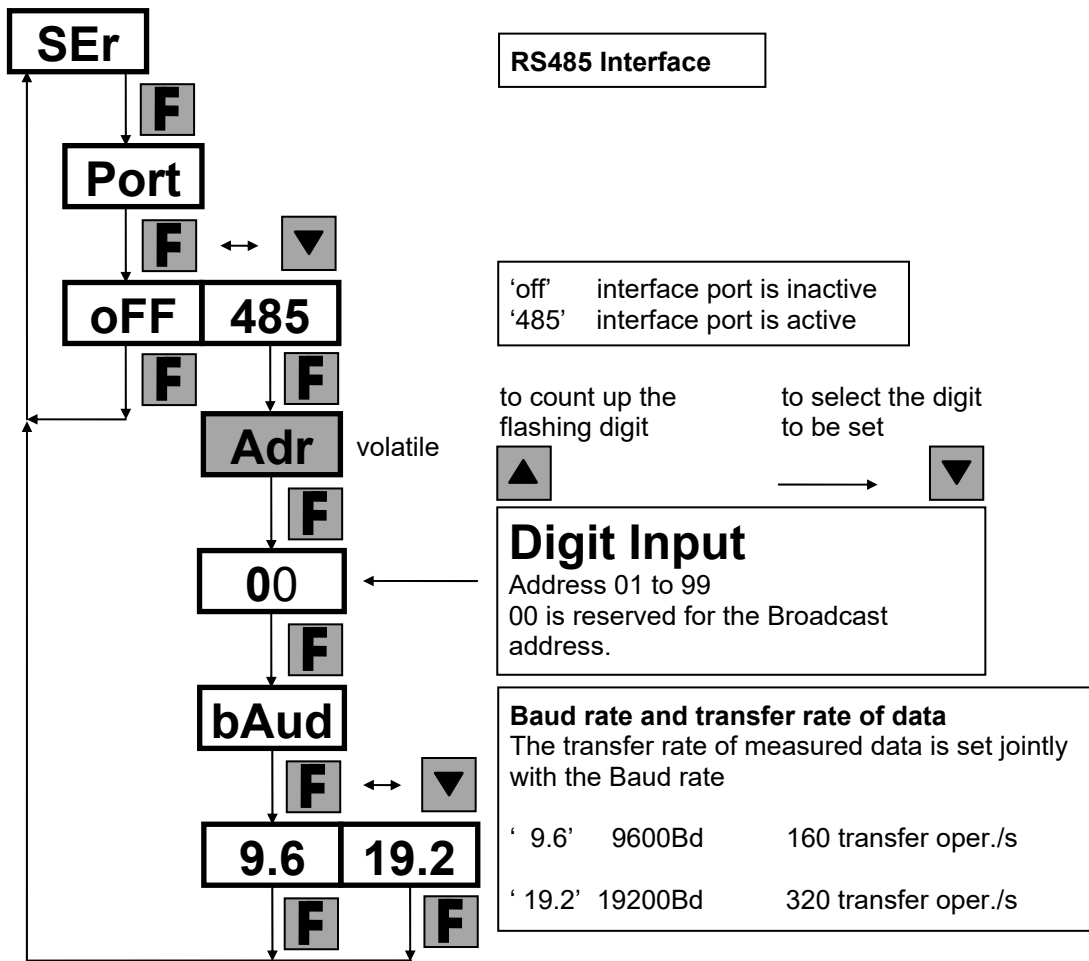

7.4.4. Parameters of the Limits (Set Points)

For either limit, the following parameters can be set:
limit value,

hysteresis of return to the under-limit condition,

mode of switching of the limit relay,

which type of measuring value is compared with the limit and

whether the entry of limits is disabled or enabled under standard operating conditions of the device.

The hysteresis for return to the under-limit condition is 100 indicating increments at most. Depending on the indicating increment, the value of hysteresis may cover a maximum indication span of 100, 200 or 500 units. If a higher value is entered, hysteresis will automatically be set to 100 indicating units.

The type of measuring value selected for comparison with the limit is linked to the mode of switching in the following manner:

Average: After the limit switch has tripped, it will immediately return to its under-limit condition if the measuring value has fallen by the hysteresis value below the limit.

Maximum: The limit switch will return to its under-limit condition only after the stored maximum value has been deleted and the current measuring value has fallen by the hysteresis value below the limit.

The input lock is for specifying whether entry of limit values by keyboard shall be enabled or disabled in standard operating conditions of the AE903.

The entry procedure is identical for either limit:

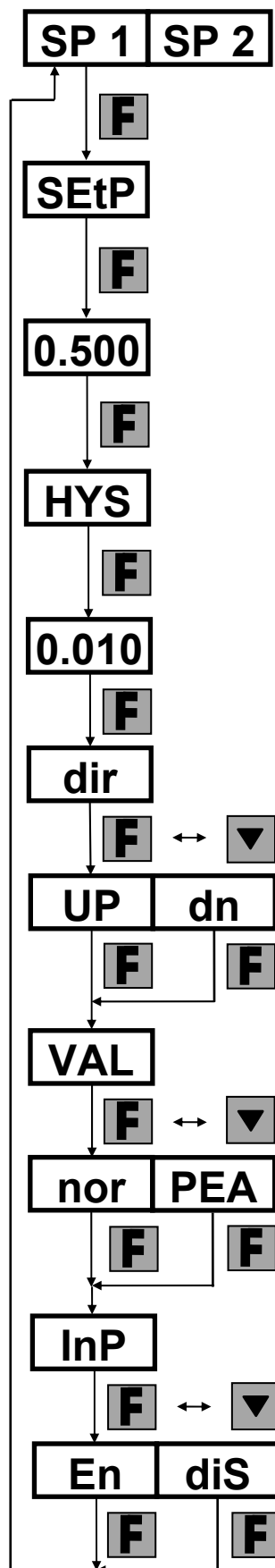

Entry of limit (set point).
From 'SEtP' on, LEDs 1 or 2, depending on which limit has been selected, will be on for the entire sub menu.

to count up the flashing digit

to select the digit to be set

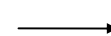

Digit Input

Entry of hysteresis.
Maximum: 100, 200 or 500 depending on selected indicating increment. If a higher value is entered, entry is limited to the above mentioned maximum.
wird auf obigen Maximalwert begrenzt.

Digit Input

Entry of switch mode of limit relay
'UP ':
Relay contact is closed when limit is exceeded
'dn ':
Relay contact is opened when limit is exceeded

Type of measuring value for comparison with limit
'nor ':
average (standard)
'PEA ':
Maximum value (peak)

Enabling of entry if standard program is run
'En ':
Entry enabled
'diS ':
Entry disabled

7.4.5. Scaling of Analog Output

This is to select the indicating range on which the output voltage of the analog output shall fall in the range within 0 V to 4 V. If values outside the selected range are indicated, the output voltage will stop at 0 V or 4 V, respectively.

If the indicated value for output voltage 0 V is higher than the indicated value for output voltage 4 V, the output voltage will drop with rising indication.

The indicating range must encompass at least 100 steps (i. e. difference of indications 100, 200 or 500, depending on the indicating increment). If a smaller indicating range is entered, error message 'E AL' (Error Analog output, display difference too Low) will appear. The permissible maximum difference of indications is 3999 indicating steps. This value corresponds to the maximum internal resolution of the device. The entry of indicating steps is monitored by the software. If too great an indicating range is entered, error message 'E AH' (Error Analog output, display difference too High) will appear.

With "VAL" it is selected whether from "quick the analog output" normal value or from the maximum value one derives.

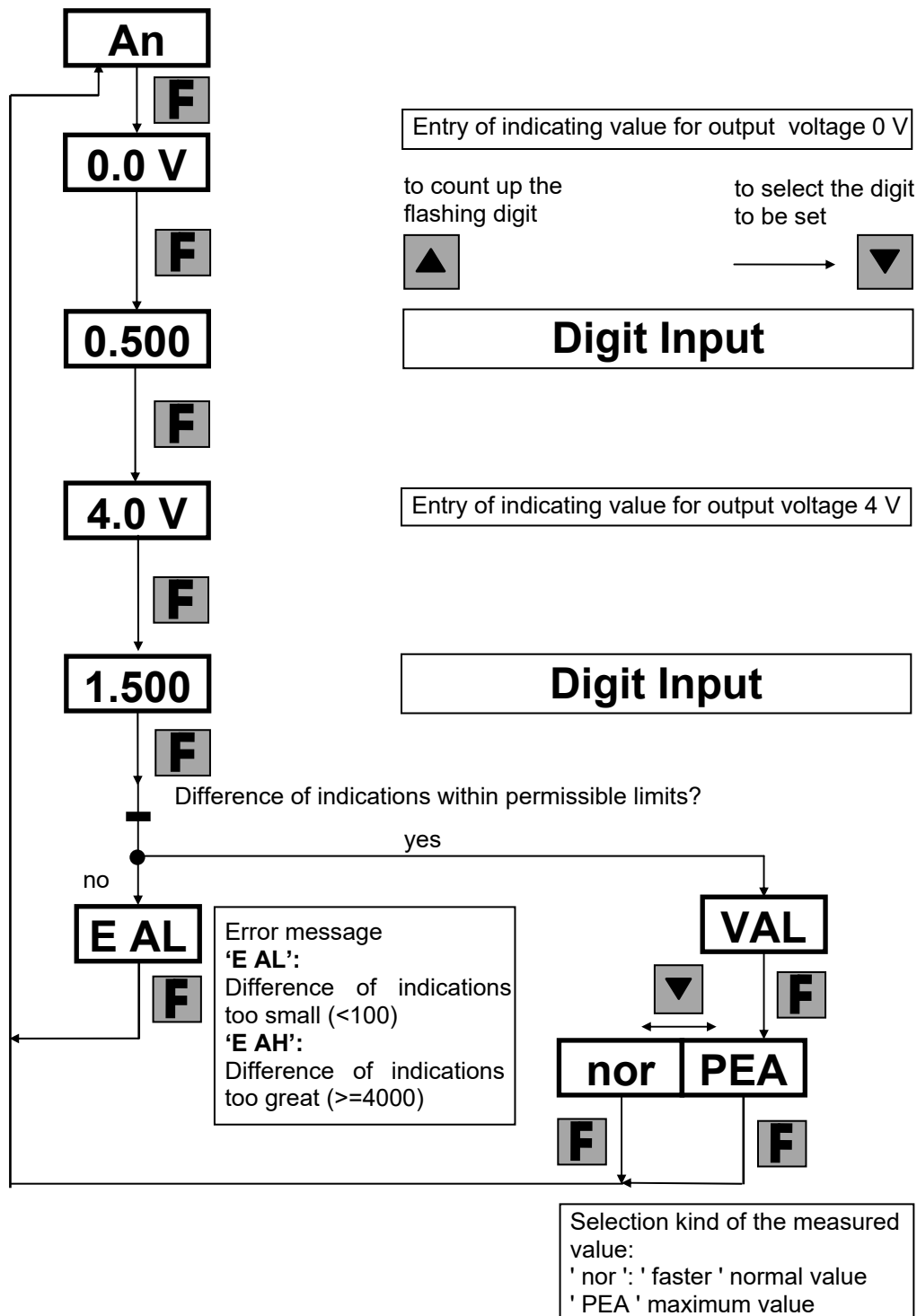

7.4.6. Overload and Underload Limits

This is to enter the **GROSS** indications at which overload or underload, respectively shall be signalled. Setting to zero (taring) will not have any effect on these limits.

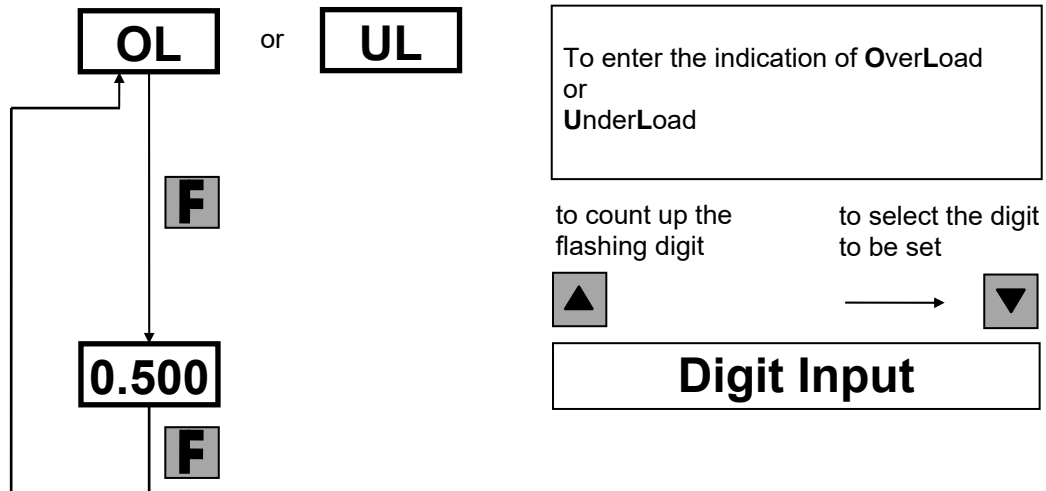

7.4.7. Power-On Zero Range

This is to enter the permitted difference between measuring value and calibrated zero for which zero shall be corrected when the device is switched on. It will be retained until the device is switched off. If the measuring difference is beyond the specified range when the device is switched on, no correction will be made.

Power-on zero setting is disabled after entry of '0000'.

Power-on zero setting works independently of the zero setting (taring) by keyboard entry when the standard measuring program is run.

ATTENTION!

Be cautious when entering this setting because power-on zero setting can take effect in the entire indicating range. Since the indication of overload is always based on the effective zero (calibrated zero plus power-on zero), high values of the power-on zero setting may cause the connected transducer to be overloaded without overload being signalled. We suggest that you should work without power-on zero.

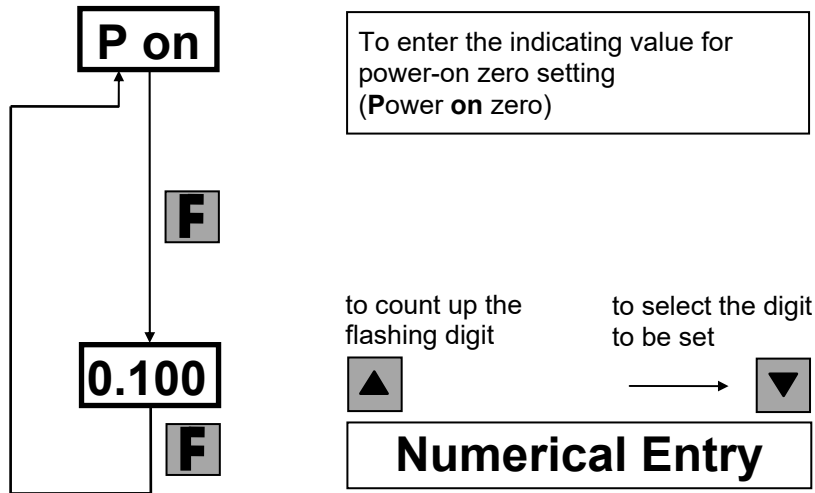

7.4.8. To Select the Function of the Trigger Input

The state of the trigger signal is included in the measuring data telegram of the serial interface, irrespective of which trigger function has been selected.

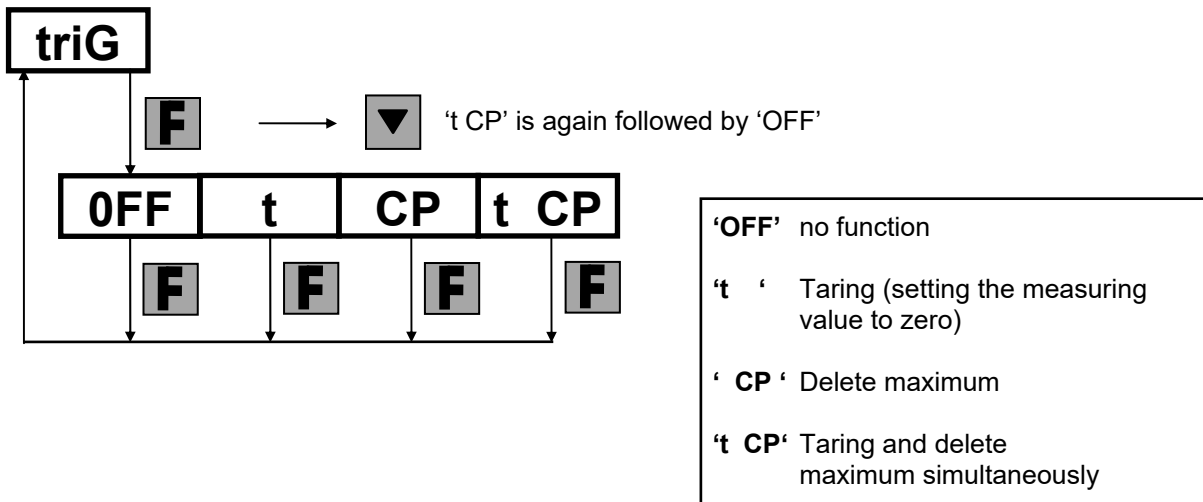

8. PC Programm

Only for devices with RS232 interface

XKS030.EXE is a simple PC program suitable for transferring the measured values to a PC at a fast rate. Both the measured values and the operating conditions are transferred. In addition to the numerical indication, a running graph will be shown in a similar way an oscilloscope would do. The series of measured values can be saved in a file.

The program runs under any WINDOWS system equal to or higher than version 3.11.

9. EC Declaration of conformity

A.S.T. - Angewandte System Technik GmbH
Mess- und Regeltechnik



EG-Konformitätserklärung **EC Declaration of Conformity**

No. 28/16

Hersteller: A.S.T. - Angewandte System Technik GmbH
Manufacturer: Mess- und Regeltechnik

Anschrift: Marschnerstraße 26, 01307 Dresden
Adress: Bundesrepublik Deutschland

Produkt-
bezeichnung: Mobile Anzeige AE 903.21
Product description: Mobile Display AE 903.21

Das bezeichnete Produkt stimmt in der von uns in Verkehr gebrachten Ausführung mit den Vorschriften folgender Europäischer Richtlinien überein:
The product described above in the form as delivered is in conformity with the provisions of the following European Directives:

2014/30/EU Richtlinie des Rates zur Angleichung der Rechtsvorschriften der Mitgliedsstaaten über die elektromagnetische Verträglichkeit.
Council Directive on the approximation of the laws of the Member States relating to electromagnetic compatibility.

Die Konformität mit der Richtlinie 2014/30/EU wird nachgewiesen durch die Einhaltung folgender harmonisierter Normen:
Conformity to the Directive 2014/30/EU is assured through the application of the following harmonised standards:

Störfestigkeit: Interference resistance:	DIN EN 61000-6-2:2006-03
Störaussendung: Emitted interference:	DIN EN 61000-6-3:2011-09

Dresden, den 14.10.2016

i. A. Heinrich
gez. Dr.-Ing. Gerd Heinrich
Qualitätssicherung / Quality assurance

A.S.T. - Angewandte System Technik GmbH
Mess- und Regeltechnik
Marschnerstraße 26, D-01307 Dresden

<http://www.ast.de>
Tel (0351) 44 55 30
Fax (0351) 4455-451

Geschäftsführer:
Matthias Boeck
HRB-Nr.: 5910
Kreisgericht
Dresden

Bankverbindung:
Ostsächsische
Sparkasse Dresden
BLZ 850 503 00
Konto 3120 1040 93